

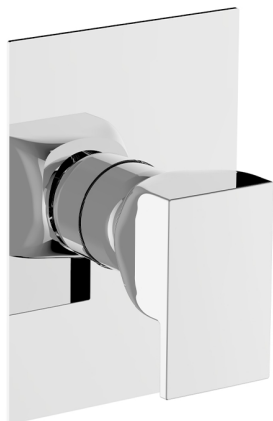

## Parte esterna monocomando doccia incasso HI-RISE



MODELLO **RI003000**

Parte esterna monocomando doccia incasso, senza parte incasso, per art. ZA005300-ZA005301

### FINITURE DISPONIBILI

-  **21** 21 Cromo
-  **6X** 6X Bianco Opaco/Oro Spazzolato
-  **6V** 6V Bianco Opaco/Nichel Spazzolato
-  **5G** 5G Oro Rosa
-  **4Q** 4Q Bianco Opaco
-  **40** 40 Nero Opaco
-  **2W** 2W Oro Spazzolato
-  **2F** 2F Nichel Spazzolato
-  **24** 24 Oro
-  **7W** 7W Nero Opaco/Oro Spazzolato

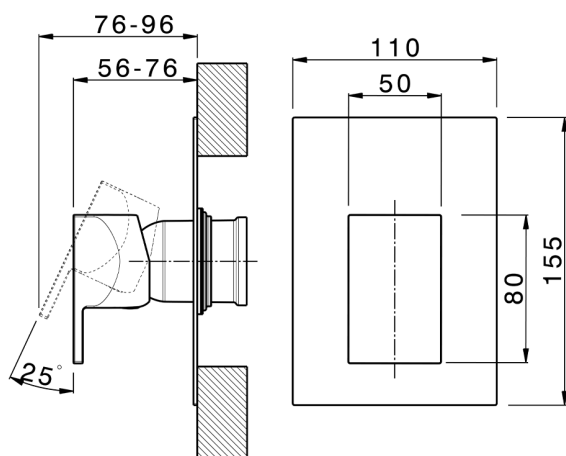

### CARATTERISTICHE

Installazione **Incasso**  
 Parti Incasso necessarie **ZA005301**  
**ZA005300**



## Parte incasso monocomando doccia INCASSO

MODELLO **ZA005301**

Parte incasso monocomando doccia, doccia incasso 1/2", senza parte esterna, con silenziatori



FINITURE DISPONIBILI

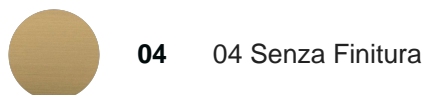

CARATTERISTICHE

Ricambio Cartuccia **ZZ94035000**

Incasso **1**

**Cartuccia Monocomando 35 mm**

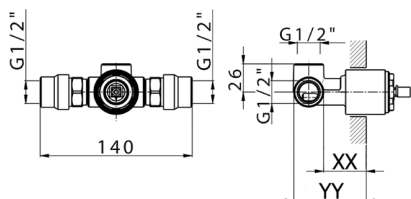

Piastra/Plate/Plaque/Platte/Placa

2-3mm: XX 27-47 YY 54-74

10mm: XX 16-40 YY 43-68



## Parte incasso monocomando doccia INCASSO

MODELLO **ZA005300**

Parte incasso monocomando doccia, doccia incasso 1/2", senza parte esterna



FINITURE DISPONIBILI



**04** 04 Senza Finitura

CARATTERISTICHE

Ricambio Cartuccia **ZZ94035000**

Incasso **1**

**Cartuccia Monocomando 35 mm**

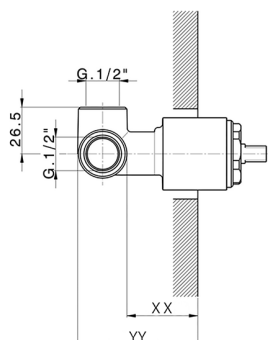

Piastra/Plate/Plaque/Platte/Placa

2-3mm: XX 27-47 YY 54-74

10mm: XX 16-40 YY 43-68



2023-07-24