

Parte incasso rubinetto 1/2" INCASSO

MODELLO **ZA003340**

Parte incasso rubinetto 1/2", apertura in senso antiorario



FINITURE DISPONIBILI

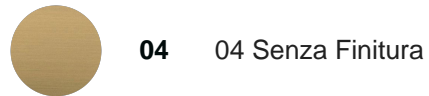

CARATTERISTICHE

Incasso **1**

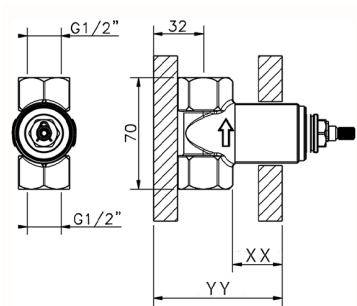

Piastra/Plate/Plaque/Platte/Placa
 2-3mm: XX 31-46 YY 80-95
 10mm: XX 25-40 YY 76-91



2023-08-23