







Miscelatore monocomando vasca ROADSTER ACCENT

MODELLO **RA000130**

Miscelatore monocomando vasca, senza completo doccia, attacco per flessibile 1/2" M



FINITURE DISPONIBILI

-  **21** 21 Cromo
-  **2B** 2B Nichel Lucido
-  **2F** 2F Nichel Spazzolato
-  **2Q** 2Q Black Titanium
-  **40** 40 Nero Opaco
-  **4Q** 4Q Bianco Opaco

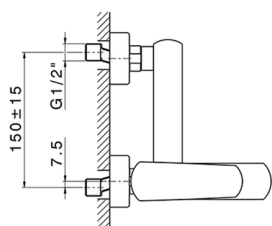
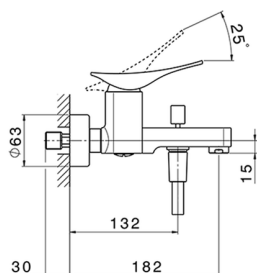

CARATTERISTICHE

Ricambio Cartuccia **ZZ96799000**

Cartuccia Monocomando 35 mm



Miscelatore monocomando vasca ROADSTER ACCENT

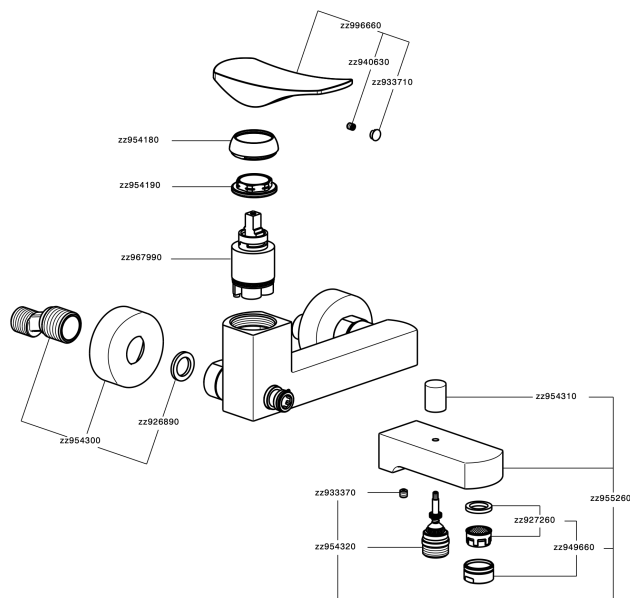

RA000130

<https://www.cisal.it/miscelatore-monocomando-vasca-roadster-accentra000130>

2023-08-19