

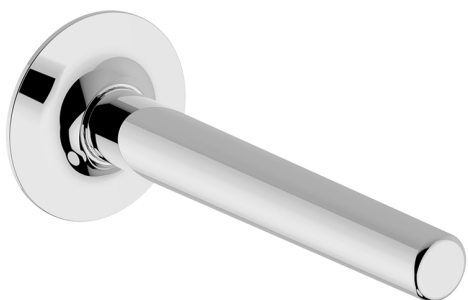



Bocca di erogazione VITA

MODELLO **VI000240**

Bocca di erogazione, L.200 mm, attacco 1/2" M



FINITURE DISPONIBILI

-  **21** 21 Cromo
-  **2Q** 2Q Black Titanium
-  **40** 40 Nero Opaco
-  **4Q** 4Q Bianco Opaco

CARATTERISTICHE

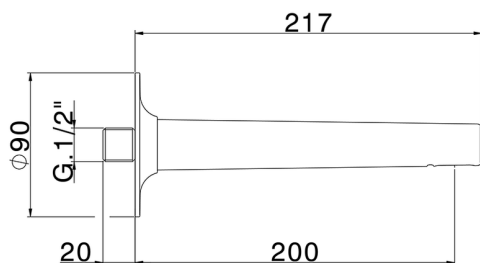

Bocca di erogazione VITA

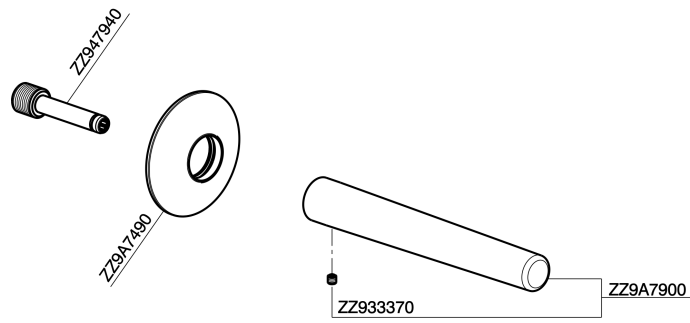

VI000240

<https://www.cisal.it/bocca-di-erogazione-vitavi000240>

2023-08-19