





Parte esterna termostatico doccia incasso NUOVA LESS

MODELLO **LN007200**

Parte esterna termostatico doccia incasso, senza rubinetto d'arresto, senza parte incasso, per art. ZA007220

FINITURE DISPONIBILI

-  **21** 21 Cromo
-  **2F** 2F Nichel Spazzolato
-  **40** 40 Nero Opaco
-  **4Q** 4Q Bianco Opaco

CARATTERISTICHE

Installazione **Incasso**
Parti Incasso necessarie **ZA007220**

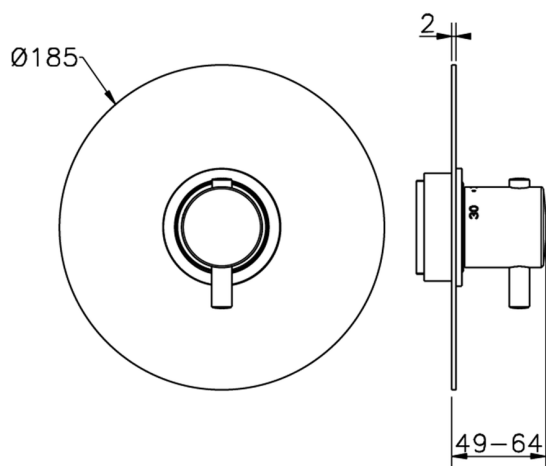

Termostatico

Il Termostatico Cisal è il tuo personale gestore dell'acqua che ti aiuta a gestire e controllare acqua ed energia senza sprechi.



Parte incasso termostatico 3/4" INCASSO

MODELLO **ZA007220**

Parte incasso termostatico 3/4", senza rubinetto d'arresto, senza parte esterna

FINITURE DISPONIBILI



04 04 Senza Finitura

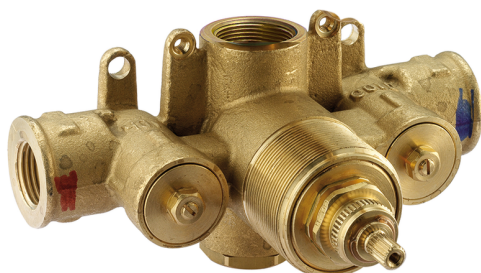

CARATTERISTICHE

Ricambio Cartuccia **23.51A.HF**

Incasso **1**

Cartuccia Termostatica HF

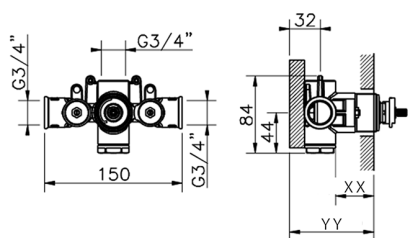

Piastra/Plate/Plaque/Platte/Placa

2-3mm: XX 25-40 YY 76-91

10mm: XX 16-31 YY 65-80



Termostatico

Il Termostatico Cisal è il tuo personale gestore dell'acqua che ti aiuta a gestire e controllare acqua ed energia senza sprechi.



2023-08-18