

MONET | MNV002

WC terra 36*52 H42
Back to wall Rimless WC 36*52 H42

Peso: KG 27
Weight: KG 27

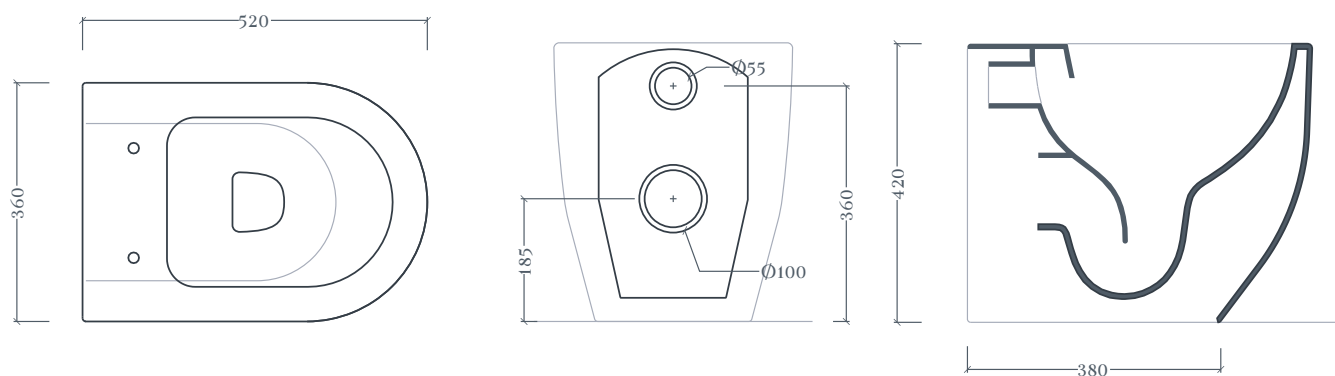

ADJUSTABLE FLUSH SYSTEM TYPES

* Connessioni di scarico regolabili
da acquistare separatamente

Adjustable drainage connections
to be purchased separately

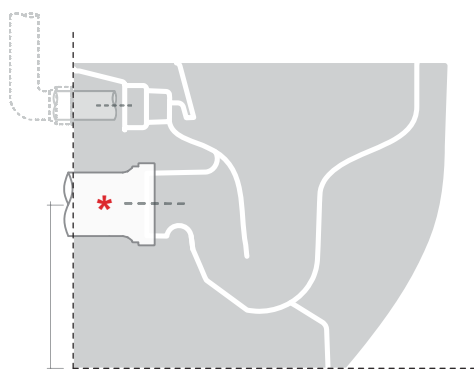

Scarico a parete predisposto - h. da 18 a 23 cm
Wall discharge arrangement - h. from 18 to 23 cm

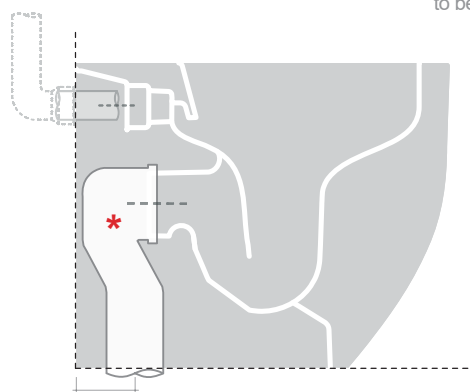

Scarico a pavimento predisposto - da 8 a 19 cm
Arrangement discharge to floor - from 8 to 19 cm

N.B. Le misure indicate possono subire una variazione dell'0,6% circa, dovuta ad usura stampi e a variazioni delle caratteristiche tecniche relative alle materie prime che compongono l'impasto.

N.B. Indicated size could have a variation of about 0,6% due to usure of the moulds or the variations of the materials' technical characteristics used in the mixture.

MONET | MNV002

WC terra 36*52 H42
Back to wall Rimless WC 36*52 H42

Peso: KG 27
Weight: KG 27

WALL DISCHARGE ARRANGEMENT

ACA075

Raccordo scarico parete P traslato
P trap adjustable pipe

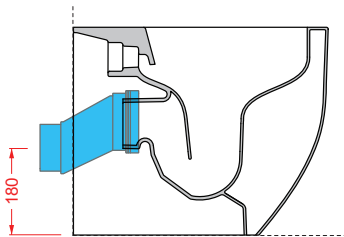

ACA004

Raccordo scarico parete P
Pipe at wall P

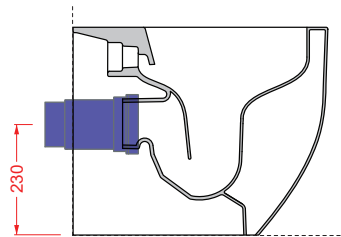

ACA035

Cannotto traslato per modifica
ingresso acqua +/- 2 cm

Adjustable pipe for water inlet change +/- 2 cm

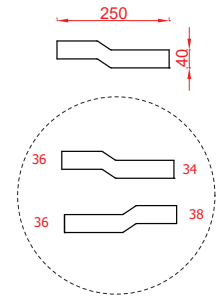

FLOOR DISCHARGE ARRANGEMENT

ACA074 + ACA076

Curva tecnica traslata + manicotto concentrico
Adjustable pipe + concentric pipe

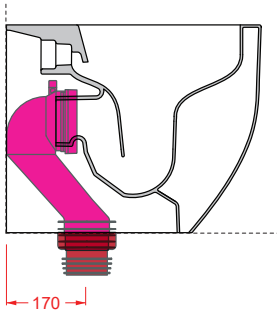

ACA074 + ACA077

Curva tecnica traslata + manicotto eccentrico 2 cm
Adjustable pipe + eccentric pipe 2 cm

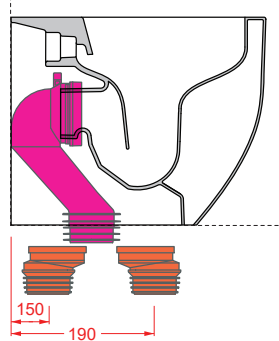

Connessioni di scarico regolabili grazie agli
abbinamenti delle curve con i manicotti (concentrico od
eccentrici) - da acquistare separatamente

Adjustable drainage connections thanks to the
combinations of the curves with the pipes (concentric
or eccentric) - to be purchased separately

ACA005 + ACA076

Curva tecnica S + manicotto concentrico
Elbow at floor S + concentric pipe

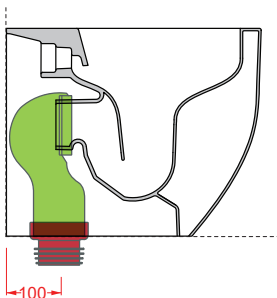

ACA005 + ACA077

Curva tecnica S + manicotto eccentrico 2 cm
Elbow at floor S + eccentric pipe 2 cm

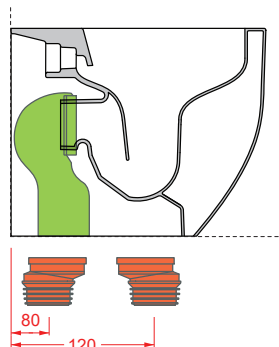

ACA005 + ACA078

Curva tecnica S + manicotto eccentrico 4 cm
Elbow at floor S + eccentric pipe 4 cm

