





## Parte esterna monocomando doccia incasso NUOVA LESS

MODELLO **LN003000**

Parte esterna monocomando doccia incasso, senza parte incasso, per art. ZA005300



### FINITURE DISPONIBILI

-  **21** 21 Cromo
-  **2F** 2F Nichel Spazzolato
-  **40** 40 Nero Opaco
-  **4Q** 4Q Bianco Opaco

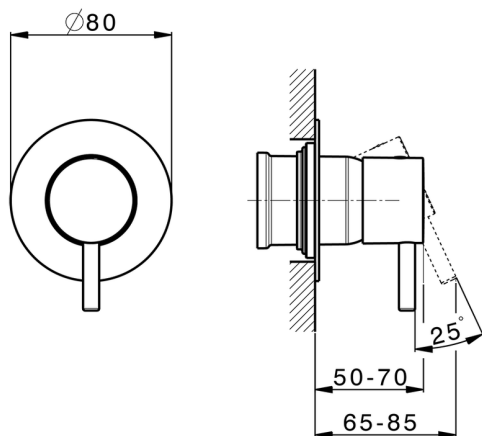

### CARATTERISTICHE

Installazione **Incasso**  
 Parti Incasso necessarie **ZA005301**  
**ZA005300**



## Parte esterna monocomando doccia incasso NUOVA LESS

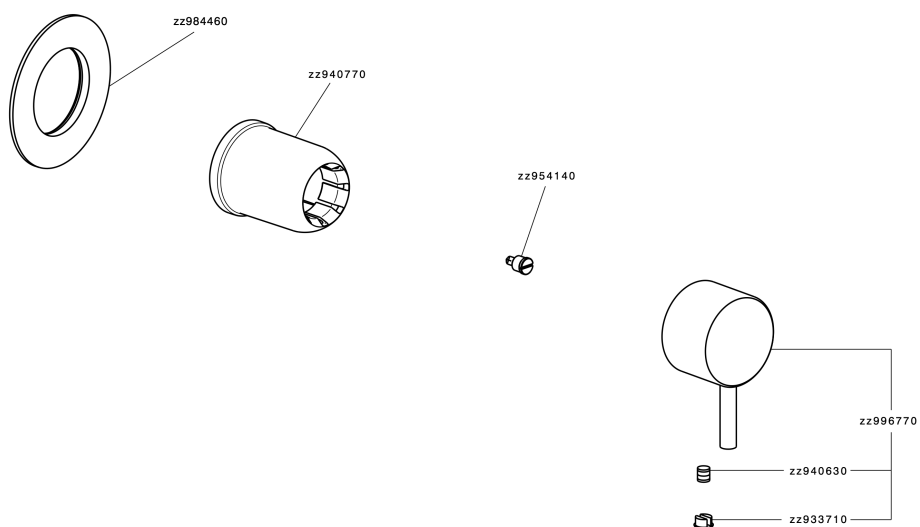

LN003000

<https://www.cisal.it/parte-esterna-monocomando-doccia-incasso-nuova-lessln003000>

## Parte incasso monocomando doccia INCASSO

MODELLO **ZA005301**

Parte incasso monocomando doccia, doccia incasso 1/2", senza parte esterna, con silenziosi



FINITURE DISPONIBILI



**04** 04 Senza Finitura

CARATTERISTICHE

Ricambio Cartuccia **ZZ94035000**

Incasso **1**

**Cartuccia Monocomando 35 mm**

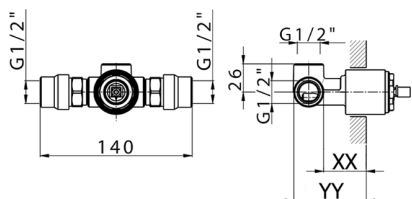

Piastra/Plate/Plaque/Platte/Placa

2-3mm: XX 27-47 YY 54-74

10mm: XX 16-40 YY 43-68



## Parte incasso monocomando doccia INCASSO

MODELLO **ZA005300**

Parte incasso monocomando doccia, doccia incasso 1/2", senza parte esterna



FINITURE DISPONIBILI



**04** 04 Senza Finitura

CARATTERISTICHE

Ricambio Cartuccia **ZZ94035000**

Incasso **1**

**Cartuccia Monocomando 35 mm**

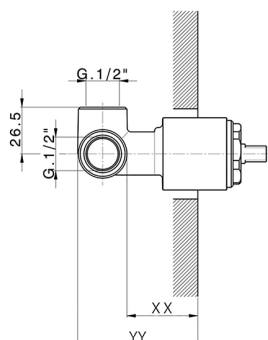

Piastra/Plate/Plaque/Platte/Placa

2-3mm: XX 27-47 YY 54-74

10mm: XX 16-40 YY 43-68



2023-08-18