

Parte incasso monocomando free-standing INCASSO

MODELLO **ZA004510**

Parte incasso monocomando free-standing

FINITURE DISPONIBILI

 **04** 04 Senza Finitura

CARATTERISTICHE

Incasso **1**

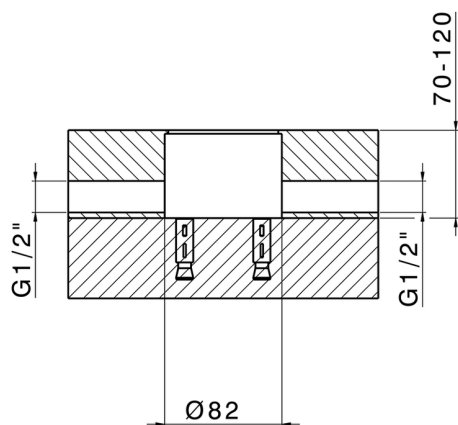
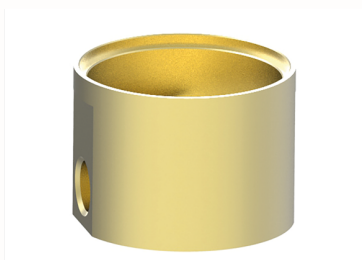

2023-07-24